

OTx

SPECIFICATION MANUAL

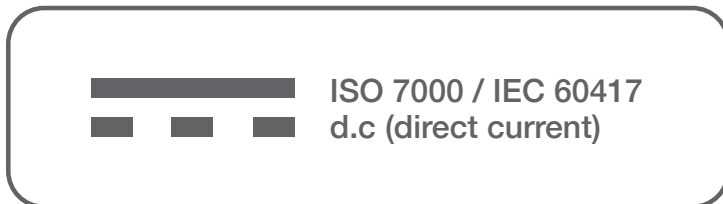

Glossary of terms



dB	Decibel
dBm	Decibel milliwatts
FibreIRS™	Fibre Integrated Reception Systems
GTU	Gateway Termination Unit
H	Horizontal Wideband (290-2340MHz)
LED	Light Emitting Diode
LNB	Low Noise Block
mA	milliamps
ODU	OutDoor Unit
OTx	Optical Transmitter
PSU	Power Supply Unit
RF	Radio Frequency
V	Vertical Wideband (290-2340MHz)

Introduction

The purpose of this guide is to enable the successful installation of the Global Invacom FibreIRS system, utilising the OTx at the headend.

This guide assumes that:

- A site survey has been completed; the location of the dish has been chosen and the dish has been installed.
- The location for the OTx has been selected.
- Passive Optical Network (PON) has been planned and installed correctly; using Global Invacom approved optical splitters.
- Approved optical cables have been installed either using Global Invacom pre-terminated optical patch cables or un-terminated cable, which has been successfully site terminated.
- All optical connectors have been cleaned prior to making connection and, where required, Global Invacom barrel adaptors have been used.

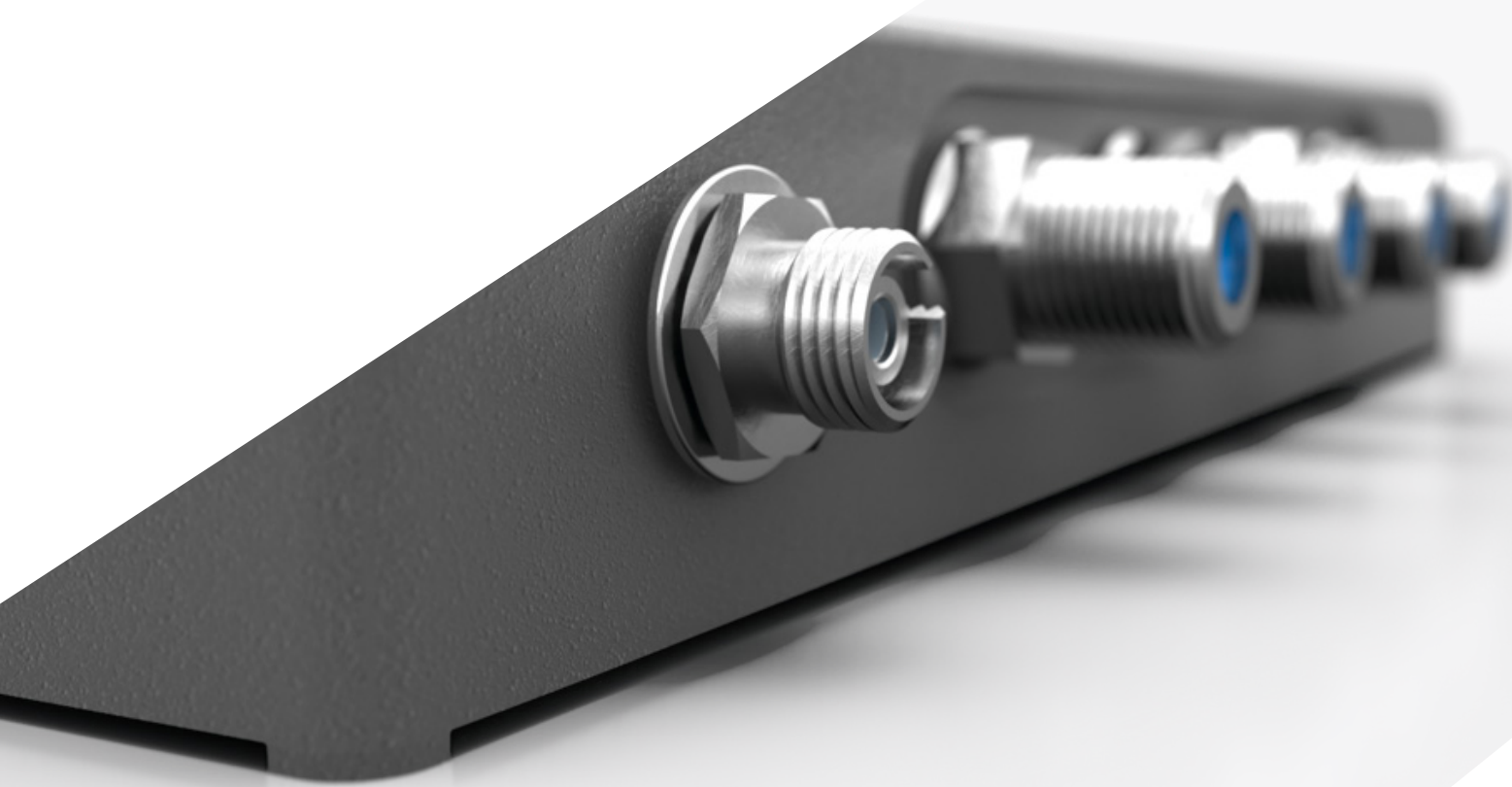

Connecting the OTx

The OTx has been designed to be either externally mounted i.e directly onto the pole behind a dish (using the supplied mounting bracket) or internally on a wall / in a cabinet. Please refer to diagram typical topology for example system.

Fibre Connection

- Clean the output fibre optical connector and check the optical power using a suitable optical power meter. Optical power out of the OTx should be +7dBm 0.5dB.
- Clean the optical connector and make a connection to the optical output of the OTx, ensuring the keyway is aligned.
- **Important** - The gel boot supplied should be clipped around the FC/UPC connector to ensure weather protection. Performance / lifespan may be affected if not fitted.
- Fibre cable should be singlemode and should be suitable for the environment installed.
- Global Invacom specifies a minimum G652D for the performance of the fibre cable but G657A or above is recommended.

Coaxial connections

- Ports labelled V or H should be connected to a suitable wideband LNB (recommended D000430) ensuring correct polarisations are connected to the relevant ports.
- Voltage is supplied for LNB powering. V = 12V, H = 20V. Maximum current 500mA inc terrestrial.
- Port labelled FM/DAB/DTT input should be connected to your terrestrial antennas using an appropriate combiner. Signals should be filtered and levelled for optimum performance.
- Voltage supplied on terrestrial input is 12V for powering a masthead amplifier.
- If terrestrial input is connected to a device not rated for a voltage, then a DC block should be installed between the OTx and the device.

Powering

- The OTx can be directly powered on the F connector power input using a 20V PSU (DVE DSA-40CA-19 200120) with the Jack to F adapter.
- The mains adapter is the disconnect device for the unit. Please ensure it is easily accessible.
- LED on the OTx is to indicate correct powering of unit. The LED should be a constant green.
- Maximum current draw 350mA excluding current on connected inputs.

OTx Connections



Typical Connection

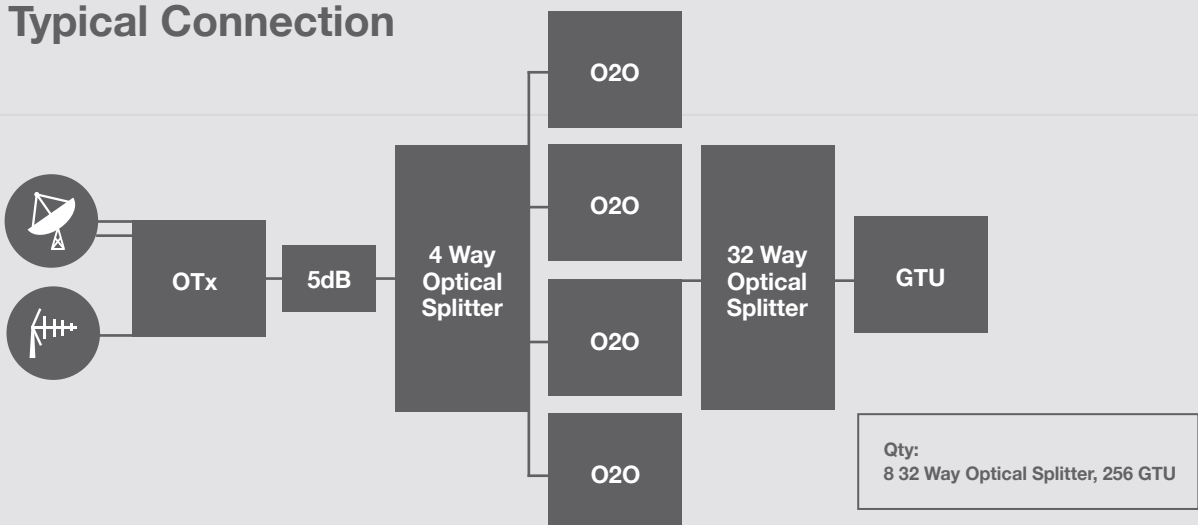

Mounting Dimensions

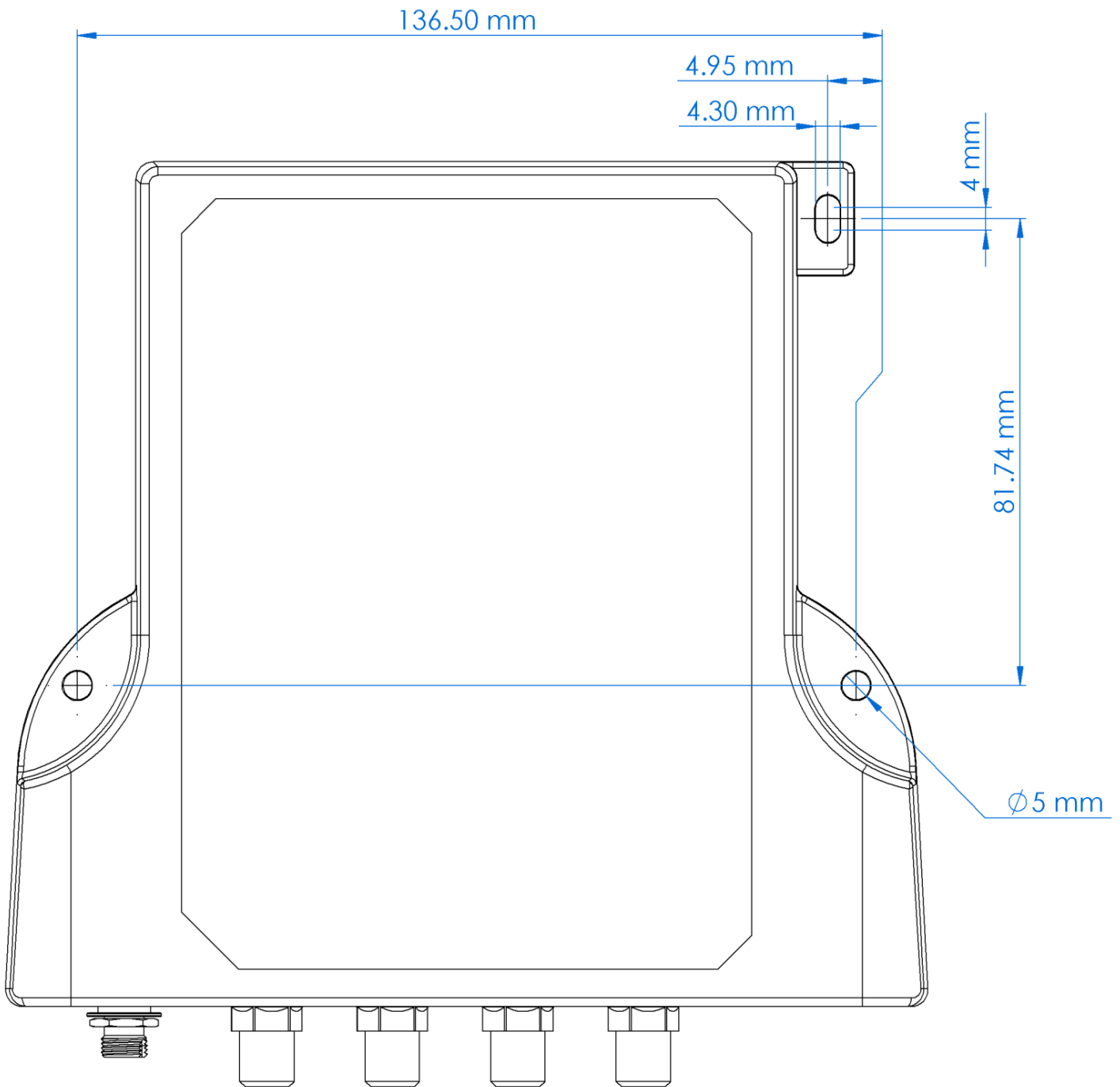

Bracket mount (pole)

Using the supplied fixings attach the pole mount bracket to the back of the OTx. Ensuring the washer is fitted and the nut tightened. This should be fitted before mounting on a mast.

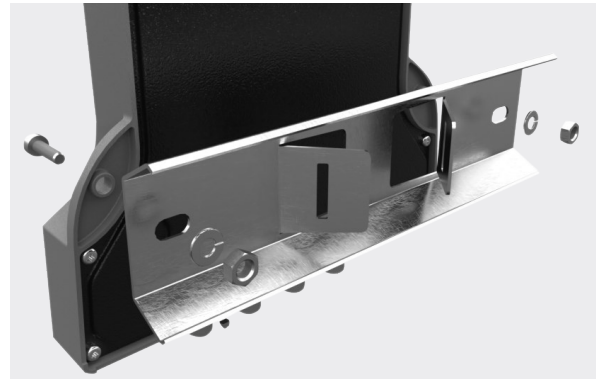

Once bracket is secured to the OTx open jubilee clip thread through slots as shown right, attach around mast and tighten using a flat bladed screwdriver.

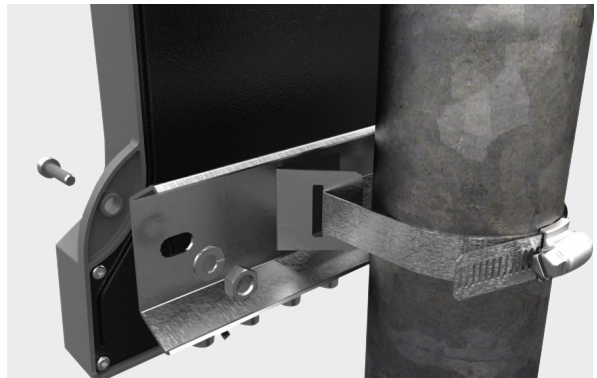

Always ensure the end of the fibre is clean before commencing.

- Align the **key-way** on the FC-UPC Connector, with the **key-way** on the fibre receptacle. Push the connector firmly into the socket.
- Ensure the **key-ways** are firmly located before rotating the coupling ring clock-wise onto the receptable (insert picture).

Note: Failure to follow these instructions correctly will result in attenuation

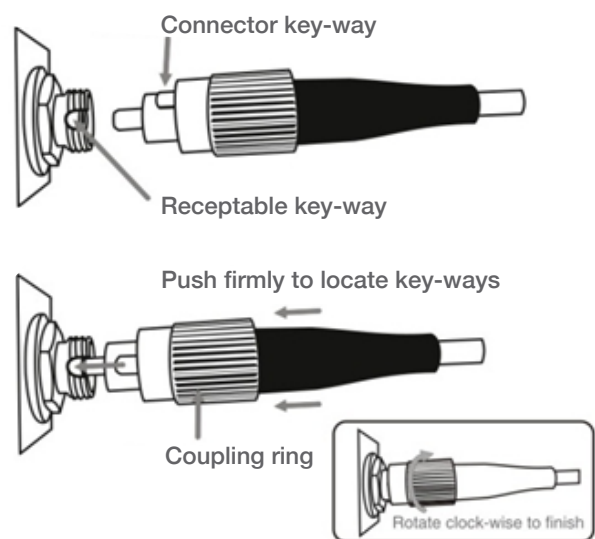

Part No:

D000410 (1310nm)

D000435 (1550nm)

D000452 (Kit 1310nm)

D000453 (Kit 1550nm)

Alternate Part No:

XXXXXXXXXX



Waste Electrical and Electronic Equipment (WEEE)

Global Invacom Ltd recognises its responsibilities and obligations under all current National and European legislation and regulations and is totally committed to and in support of compliance with the European Union Directives on Waste, Electrical and Electronic Equipment (WEEE). We are also committed to meeting our importer responsibilities and obligations, as defined in the scope of the Directives, for those products that we import into the U.K. market place.

All of our suppliers are required to ensure that all products, (that fall within the scope of the Directives), are marked with the “Do Not Dispose of in Household Waste” symbol as prescribed in the WEEE Directive.

Global Invacom Ltd has an obligation to ensure the appropriate steps are taken for the recovery and recycling of WEEE from its customers. To meet this obligation we ask customers to contact the Customer service Department (+44 (0)1438 310510) sales@globalinvacom.com once the product has reached the end of its life. Alternatively the product can be disposed of at a designated collection point for the recycling of waste electrical and electronic equipment.



www.globalinvacom.com Email: sales@globalinvacom.com

Global Invacom cannot be held responsible for damage caused to equipment during, or following the Installation of the product. For best results always have satellite accessories installed by a professional Installer. Global Invacom reserve the right to change or amend products without prior notice.

Copyright Global Invacom Ltd 2021 PRN: WEE/KF0056TR PCS: B2B Compliance Ltd

Global Invacom Ltd. Freeman House, John Roberts Business Park, Pean Hill, Canterbury, Kent CT5 3BJ